

GRUNDIG
made for you

COLOR TELEVISION

VISION+ 26

LXW 68-9740 Dolby

VISION+ 32

LXW 82-9740 Dolby

de

en

fr

it

nl

CONTENTS

3-4

Set-up and safety

5-6

Connection and preparation

5
6

Connecting the antenna and power cord
Putting batteries in the remote control

7-10

Overview

7
8-9
9
10

Connections on the television set
The remote control (TV mode)
Operating controls on the television
The remote control (teletext mode)

11

Settings

11
11

Tuning television channels
Picture and sound settings

12

Easy Dialog system

12

»Easy Dialog System« – the interactive operating manual

13-14

TV mode

13
14

Basic functions
Zapping function

15-17

The Grundig TV Guide

15
16
16
17

The electronic television programme guide
Setting up the TV Guide
Sorting TV programmes
TV Guide settings

18-19

Teletext mode

18
18
18-19

TOP text or FLOF text mode
Normal text mode
Additional functions

20-25

Using external devices

20-22
22
23
23
24
24
25

Connecting external devices
Changing the AV settings
Video recorder, DVD player or set-top box
Headphones
Decoder or satellite receiver
Digital multi-channel amplifier/AV receiver
Camcorders

26

Operation as a PC monitor

26

Connecting a PC

27-30

Retrofitting a digital receiver

27
28
29-30

Connecting a micro digital receiver to a television set
Installing on the television set
Operating the receiver with the television remote control

31-33

Information

31
29
30

Technical data, Service information for dealers, Environmental note
Troubleshooting
Additional Information for units sold in the UK.

SET-UP AND SAFETY

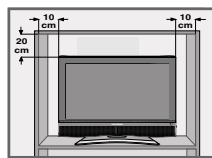

Please note the following instructions when setting up the television set:

This television is designed to receive and display video and audio signals. Any other use is expressly prohibited.

The ideal viewing distance is five times the diagonal screen size. Light falling on the screen impairs picture quality.

To assure sufficient ventilation make sure there is enough space around it in the wall unit.

The television is designed for use in dry rooms. If you do use it outdoors, make sure it is protected from moisture such as rain or splashing water. Never expose the television set to moisture.

Do not place any vessels such as vases on the television, as they may spill liquid, thus presenting a safety risk.

Place the television on a hard, level surface. Do not place any objects such as newspapers on the television or put cloth or similar items under it.

Do not place the television close to heating units or in direct sunlight, as this will impair cooling.

Heat build-up can be dangerous and shortens the service life of the television. For reasons of safety, have a repairman remove any dirt in the set from time to time.

Never open the television under any circumstances. No warranty claims are accepted for damage caused by incorrect handling.

Make sure the power cord or the power supply unit (if provided) are not damaged.

The television set may only be operated with the mains cable/adaptor supplied.

Thunderstorms are a danger to all electrical devices. Even when the television is switched off, it can be damaged by a lightning strike to the mains or the antenna. Always disconnect the mains and antenna plugs during a storm.

Use a damp, soft cloth to clean the screen. Do not use water with soap or detergent.

Note:

Do not connect any other equipment while the device is switched on. Switch off the other equipment as well before connecting it.

Do not plug in the power cord of your device until you have connected the external equipment and the antenna.

Make sure the power plug is freely accessible.

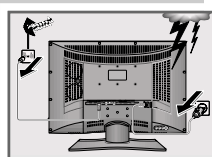
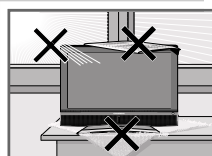

SET-UP AND SAFETY

When deciding where to put the device, remember that furniture is often coated with various types of varnish and plastic. Many of these contain chemicals which can corrode the feet of the device, leaving marks on the surface of the furniture which can be difficult or impossible to remove.

The screen of your LCD television meets the highest quality standards and has been checked for pixel faults.

Despite the great care taken in manufacturing, it is technically impossible to guarantee that some pixels will not be defective.

Provided they are within the thresholds specified by the DIN norm, pixel faults of this kind cannot be regarded as a defect as defined by the warranty.

Caution:

If you want to use a wall bracket for your television, make sure you read the assembly instructions for the wall bracket carefully or have your specialist dealer mount it for you.

When buying the wall bracket, make sure that all the fastening points needed on the television are there on the wall bracket and that they are all used when it is mounted.

CONNECTION AND PREPARATION

Connecting the antenna and power cord

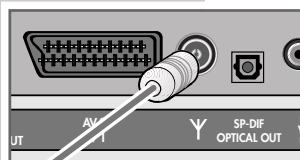
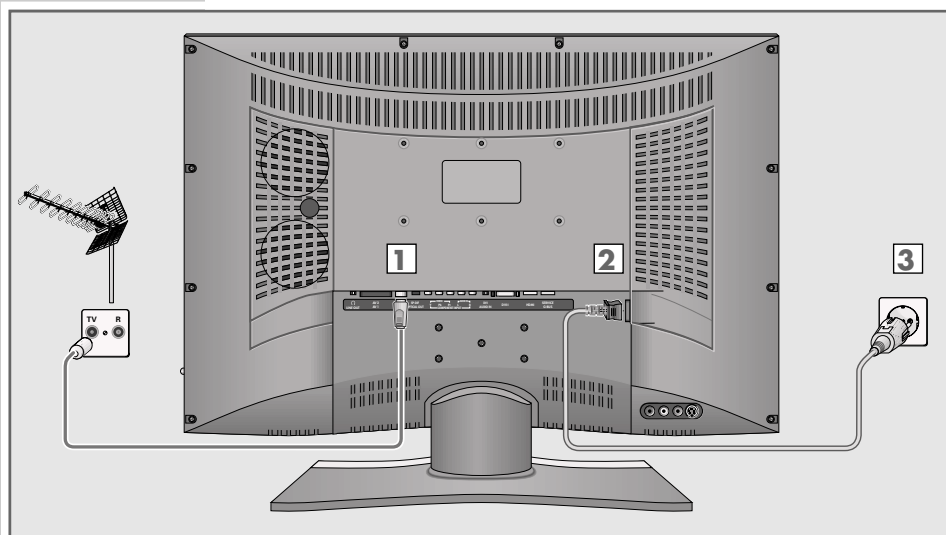

- 1 Plug the roof antenna cable into the antenna socket »Y« on the television.
- 2 Plug the power cord supplied into the power socket on the television.
- 3 Plug the power cord into a wall socket.

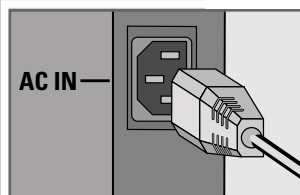

Notes:

Do not plug in the power cord of your device until you have connected the external equipment and the antenna.

Only connect the television using the power cord supplied to a suitable earthed safety socket.

Do not use an adapter plug or extension lead which does not meet the applicable safety standards. Do not tamper with the power cord.

CONNECTION AND PREPARATION

High definition – HD ready

Your television can playback high-definition television signals (HDTV).

You can connect the input sources (HDTV set-top box or High Definition DVD player) to the »HDMI« or »DVI-I« socket (digital HDTV signal).

This ensures that you can view digital HDTV programmes, even if they are copy-protected (HDCP High Bandwidth Digital Content Protection).



Putting batteries in the remote control

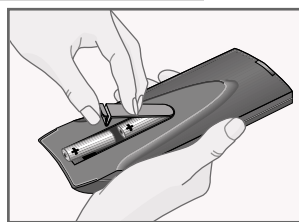

- 1 Open the battery compartment by taking off the lid.
- 2 Put in the batteries (AA, 2 x 1,5 V).
Make sure the polarity is correct.
- 3 Close the battery compartment.

Note:

If the television no longer reacts properly to remote control commands, the batteries may be flat. Always remove used batteries. The manufacturer accepts no liability for damage caused by leaking batteries.

Environmental note

Batteries, including those which contain no heavy metal, should not be disposed of with household waste. Please dispose of used batteries in an environmentally sound manner. Find out about the legal regulations which apply in your area.

OVERVIEW

Connections on the television set

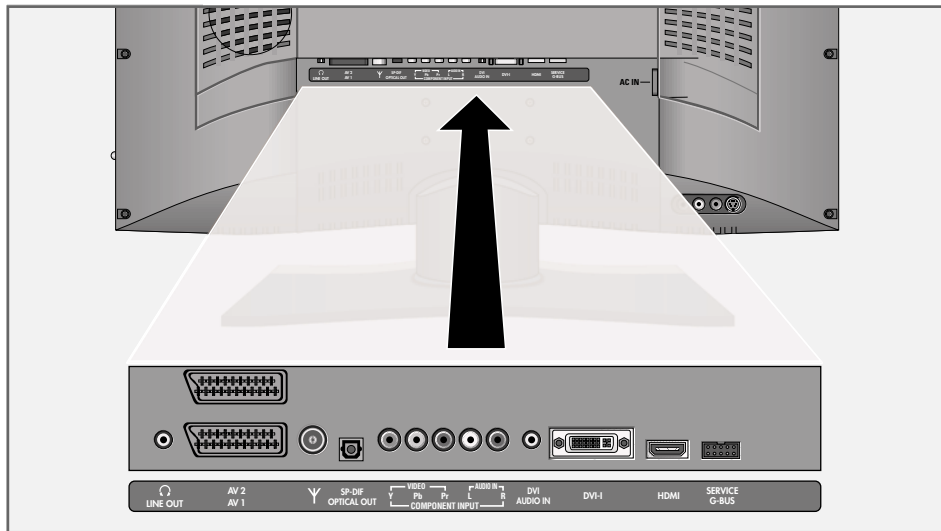

 **LINE OUT**

Headphone socket/audio output.

AV 2

SCART socket
(FBAS-Signal, RGB-Signal, Y/C-Signal).

AV 1

SCART socket
(FBAS-Signal, RGB-Signal, Y/C-Signal).



Antenna socket.

**SP-DIF
OPTICAL OUT**

Audio output for PCM signals;
for connecting a digital multi-channel audio/video
amplifier or AV receiver.

**COMPONENT
INPUT**

**VIDEO Y Pb Pr
AUDIO IN L R**

Video input (YUV signal).
Audio input (YUV signal, DVI signal).

DVI AUDIO IN

Audio input (DVI signal).

DVI-I

DVI-I socket, video input (DVI signal).

HDMI

HDMI socket, audio/video input (HDMI).

SERVICE G-BUS

Service socket for dealers.
Controlling external modules (DVB-T, DVB-S).

AC IN

Power cord socket.

L AUDIO R

Audio input for camcorder (red and white socket).

VIDEO

Video input for camcorder (yellow socket).









S-VIDEO

Video output for S-Video camcorder.

OVERVIEW

The remote control (TV mode)



-  Switches the television off (standby).
- 1...0** Switches the television on from standby mode.
Selects channels directly.
-  Calls up information on the selected function.
-  Opens the »Format« menu.
Then use **P+** or **P-** to make the selection.
- PIP** Displays an inset picture.
Returns to normal picture.
- AV** Opens the pre-selection for AV channels.
Then selection with **P+** or **P-**.
-  Sound on/off (mute).
- i** Opens the »EASY DIALOG« menu.
- Z** Zapping function.
- P+, P-** Switch the television on from standby.
Select channels step by step.
Move the cursor in the menus up and down.
-  Adjust the volume.
Move the cursor left/right.
- OK** Opens the channel list.
Activates various functions.
- TXT** Switches between teletext and TV modes.
- TV-G** Opens the TV Guide (electronic programme guide).
(TV Guide providers are not available in all countries.)
-  Opens the »Picture« menu.
-  Shows/hides the time and preset information.
-  Freeze-frame.
-  Opens the »Sound« menu.

OVERVIEW



- SCAN** Functions in teletext mode.
- PAT** Selects the split screen function.
- S** Functions in teletext mode.
- P** Functions in teletext mode.
- DR, DVD** Switches to operation of a GRUNDIG digital receiver, GRUNDIG digital receiver with hard disk (PDR), GRUNDIG DVD players or GRUNDIG DVD recorder.

Keep the appropriate button (»DR«, »DVD«) pressed down. Then press the button.

Note:

The »DR« button has been programmed for operating a GRUNDIG digital receiver (remote control level 1). The »DVD« button has been programmed for operating a GRUNDIG DVD player.

You can change this programming, see »AUX« button.

The functions available depend on the model of the device you are using.

Just try it out.

AUX

Programming the remote control for the operation of external devices.

Press »AUX« and hold it down and press three number buttons to enter the code:

»1«, »2«, »3« for a GRUNDIG DVD player.

»4«, »5«, »6« for a GRUNDIG DVD recorder.

»1«, »4«, »7« for a GRUNDIG digital receiver (remote control level 1).

»2«, »5«, »8« for a GRUNDIG digital receiver (remote control level 2).

»3«, »6«, »9« for a GRUNDIG digital receiver with a hard disc (PDR).

Operating controls on the television



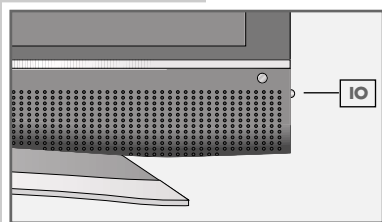

- IO** Power switch, switches the device on and off.



OVERVIEW



The remote control (teletext mode)

- 1 ... 0** Enter teletext page numbers.
-  Switches to double character height.
- i** Opens page 100.
- P+** Scrolls to the next page.
- P-** Scrolls back a page.
- TXT** Switches between teletext and TV modes.
-  (red) Scrolls back a page.
-  (green) Scrolls to the next page.
-  (yellow) Selects the next chapter.
-  (blue) Selects the next topic.
- SCAN** Overriding wait time.
- S** Calling up a sub-page directly.
- P** Page stop.
- ?** Reveal answer.

SETTINGS

Tuning television channels

The television is equipped with automatic tuning.

You start the search and can then sort the channels into your order of preference.

There are 99 presets, to which you can assign channels from the antenna or from the cable connection.

You can delete channels from the list which were found more than once or which have poor reception.

Menu language

Deutsch	Svenska	Романа
English	Česky	Български
Français	Slovensky	
Italiano	Magyar	
Nederlands	Polski	
Español	Slovensko	
Português	Hrvatski	
Dansk	Ελληνικά	
Suomi	Türkçe	
Norsk	русский	

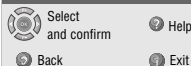

- 1 The first time you switch on the television, press »P +« , »P -« to select the dialogue language and »OK« to confirm.
- 2 Select your location with »P +« or »P -« and press »OK« to confirm.
 - Automatic tuning begins.
 - The process may take several minutes depending on the number of channels received.
 - After automatic tuning is completed, the television switches to preset 1.

Note:

In the »Preset list« menu, you can sort channels as required.

You can also add channels which come on air subsequently.

You can find more detailed instructions in the »Easy Dialog System« interactive operating manual.

The Easy Dialog System is described on page 12.

Picture and sound settings

- 1 Select the »Picture« menu by pressing »P« or the »Sound« menu by pressing »S«.
- 2 Select the item with »P+« or »P-« and press »OK« to confirm.
- 3 Change the setting with »◀«, »▶«, »P+« or »P-«.
- 4 Exit the »Picture« menu or the »Sound« menu by pressing »i«.

Note:

You can find detailed instructions on the settings in the »Easy Dialog System« interactive operating manual.

The Easy Dialog System is described on page 12.

Virtual Dolby Surround: Under license from Dolby Laboratories Licensing Corporation.

DOLBY and the Double-D symbol  are registered trademarks of the Dolby Laboratories Licensing Corporation.

EASY DIALOG SYSTEM

»Easy Dialog System« – the interactive operating manual

Your television features the »Easy Dialog System« – a kind of interactive operating manual.

This interactive operating manual has menus, a user guide and a help function to show you how to operate the television and the many numerous feature it offers.

The printed operating manual only shows you how to set up the television and provides a general overview, and is therefore very concise.

How the »Easy Dialog System« works

The main »Easy Dialog« menu is your television's control centre.

This main menu is the contents page of the »Easy Dialog Systems«. Press »i« to open it.

You can select each menu item directly by pressing »1...0«. Alternatively you can select by pressing »P +«, »P -« and then »OK« to confirm.

The user guide at the bottom of the menus shows you what functions each button performs.

If you want an explanation of a function, just press »?«.

What happens if you accidentally select the wrong menu item? No problem – just press »?« to return to the previous menu.

Once you have made all your settings or have finished reading the interactive operating manual, press »i« to return to TV mode.

Just try it out. You can't go wrong.



TV MODE

Basic functions



Switching on

- 1 Press »**IO**« on the television to switch it on.
Press »**1...0**« or »**P+**« or »**P-**« to switch on the device from standby mode.

Note:

This television is equipped with a highly-sophisticated computer. After switching on the television, it takes about 20 seconds until the operating system is loaded and you will then see a picture.

Switching to and from standby

- 1 Press »**⏻**« to switch the television to standby.
- 2 Press »**IO**« on the television set to switch it off completely.
– This saves electricity.

Selecting channels

- 1 Press »**1...0**« to select channels directly.
- 2 Press »**P+**« or »**P-**« to move up and down presets one at a time.
- 3 Open the channel list by pressing »**OK**«, select the station with »**P+**« or »**P-**« and press »**OK**« to confirm.

Selecting AV channels

- 1 To select AV channels, press »**AV**« to open the AV menu, press »**P+**« or »**P-**« to select the AV preset and »**OK**« to confirm.

Adjusting the volume

- 1 Press »**◀**« or »**▶**« to change the volume.

Muting

- 1 Press »**🔇**« to mute the sound or switch it on again.

Showing and hiding programme information, the date and time

- 1 Press »**🕒**« to show or hide the information.

Changing the picture format

The television automatically switches to the 16:9 format if this format is detected via the SCART socket.

- 1 To select the picture format, press »**🖥**« to open the »Picture format« menu and press »**P+**« or »**P-**« to select the format.

TV MODE

Freeze-frame

If you wish to view a particular scene for longer, you can “freeze” the frame of the current programme.

- 1 Press »**□□**« (yellow).
- 2 Press »**□□**« (yellow) again to quit the function.

Split screen

This function shows the television channel on the right and the teletext page on the left.

- 1 Activate the split screen function by pressing »**PAT**«.
– The television channel and the teletext page appear next to each other on the screen.
- 2 Deactivate the split screen function by pressing »**PAT**«.

Zapping function

This function remembers the channel you are currently watching while you switch over to other channels (zapping).

- 1 Press »**1...0**« or »**P+**« »**P-**« to select the channel to be stored in the zapping memory (e.g. Channel 7, PRO7) and press »**Z**« to save it.
– The channel name appears on the screen, e.g. »Z 7 PRO7«.
- 2 Press »**1...0**« or »**P+**« »**P-**« to switch over to another channel.
- 3 Each time you press »**Z**« the television switches between the channel in the memory (in this case PRO7) and the last one you were watching. This action is called zapping.
- 4 Press »**i**« to quit the zapping function.
– The display disappears.

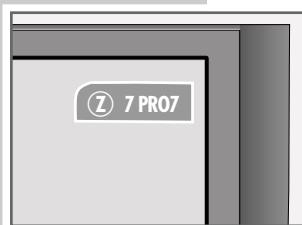

THE GRUNDIG TV GUIDE

The electronic television programme guide

The TV Guide is an electronic programme guide which provides a fast and up-to-date overview of all the pre-programmed television programmes.

Options

Programme information is provided in a database which allows you to sort information in various ways, according to the following:

- Programmes from all the broadcasting stations
- Programmes from one broadcasting station
- Programmes which are currently being broadcast from all stations
- Programmes which are currently being broadcast from one station
- You can select programmes according to topics, such as feature films, sports broadcasts, from all stations or only one.
- Programmes sorted according to the time. For example, the current programme (NOW), the programme on next (NEXT) or programmes on after a specific time.

Who provides TV Guide?

Certain stations provide a TV Guide for almost all programmes. The programme information is available for several days.

How TV Guide works

First you need to find a TV Guide provider and then activate the TV Guide.

Select a preset for the TV Guide provider and the information is imported. This information is stored even if you switch off and then on again.

It takes between 20 and 30 minutes to load all the information to the television but you can view the information that is closer to the current time after a few minutes.

The TV Guide is updated automatically as long as you have selected the preset for the TV Guide provider.

Notes:

TV Guide is not available when operating via an external receiver (analogue satellite receiver, DVB-S, DVB-T).

If you change the preset while the device is transferring the data, it is possible that not all information will be loaded.

Note the explanations to the individual functions, which you can always view with »?».

THE GRUNDIG TV GUIDE

Setting up the TV Guide

- 1 Switch on the TV Guide with »**TV-G**«.
– The TV Guide appears on the television screen.
- 2 Select the television programme (TV Guide broadcaster) with »**P+**«, »**P-**«, »**◀**« or »**▶**« and confirm with »**OK**«.
– Select a preset for the TV Guide provider and the information will be imported.







Note:

If you are not sure which TV Guide data is being transferred, you can start a search with »**🔍**«.

Sorting TV programmes

You can sort TV programmes according to time, topic and station.

- 1 Switch on the TV Guide with »**TV-G**«.
– The TV Guide appears on the television screen with the topic menu.

	All programmes
	Feature films
	Sport
	TV series
	Children's programmes
	Shows and entertainment
	News

- 2 To sort programmes according to the station, press »**?**« (blue)

or

to sort programmes according to time and day, press »**🕒**« (green)

– In the overview menu you can see the day, NOW for current programmes, NEXT for the next programmes and the times for other programmes

or

to sort programmes according to topic, press »**📁**« (yellow).

- 3 Select the station provider, time or the topic with »**P+**« or »**P-**«.
- 4 Select the programme with »**▶**« and »**P+**« or »**P-**« and press »**OK**« to switch to it.
- 5 Exit the TV Guide with »**i**«.

THE GRUNDIG TV GUIDE

TV Guide settings

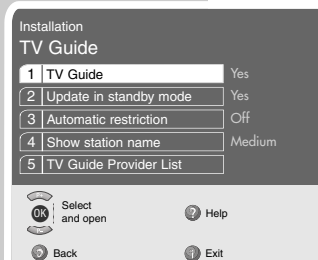

- 1 Open the »EASY DIALOG« menu by pressing »i«.
- 2 Select »Installation« with »P +« or »P -« and press »OK« to confirm.
- 3 Select »TV Guide« with »P +« or »P -« and press »OK« to confirm.
- 4 Press »P +« or »P -« to select the setting and press »OK« to confirm.
- 5 Press »P +« or »P -« to change the setting and press »OK« to confirm.

Note:

If you want an explanation of the setting, just press »?«.

- 6 Press »i« to conclude the setting.

TELETEXT MODE



TOP text or FLOF text mode

- 1 Press »**TXT**« to switch on teletext.
- 2 You can select teletext pages directly by pressing »**1...0**«. Press »**i**« to return to page 100.

Note:

At the bottom of the screen there is an info bar with red, green and – depending on the channel – yellow and blue panels. Your remote control has buttons with the corresponding colours.

- 3 Press »**⏪**« (red) to go back a page.
- 4 Press »**⏩**« (green) to go forward a page.
- 5 Press »**⏸**« (yellow) to select a chapter.
- 6 Press »**⏹**« (blue) to select a topic.
- 7 Press »**TXT**« to switch off teletext.

Normal text mode

- 1 Press »**TXT**« to switch on teletext.
- 2 You can select teletext pages directly by pressing »**1...0**«.
- 3 Scroll back a page with »**P-**«.
- 4 Press »**P+**« to scroll to the next page.
- 5 Press »**TXT**« to switch off teletext.

Additional functions

Overriding wait time

- 1 Press »**SCAN**«. – The television returns to television mode, the teletext page numbers are displayed in the upper left corner of the screen.
- 2 Enter the teletext page number with »**1...0**«. – The page number appears in red, when the page is found it changes to green.
- 3 Switch to the teletext page by pressing »**SCAN**«.

TELETEXT MODE

Increasing the character height

If you have difficulty reading the text on the screen, you can double the character height.

- 1 To enlarge the character height of a teletext page, keep pressing »«.



Page stop

A multiple page may contain several sub-pages, which are automatically scrolled by the transmitting station.

- 1 Stop the sub-pages with »P«.
- 2 Press »P« to quit the function.

Calling up a sub-page directly

If the selected teletext page contains further pages, the number of the current sub-page as well as the total number of pages is displayed.

- 1 Call up the sub-pages with »S«.
- 2 Select the sub-pages with »« (red) or »« (green).
- 3 End this sub-page function with »S«.

Reveal answer

Certain teletext pages contain hidden answers or information. These can be viewed.

- 1 Display information with »?«.
- 2 Press »?« to conceal the information.

USING EXTERNAL DEVICES

Operation with external devices

Note:

Which television socket(s) you connect your external devices to depends on the sockets the external device is equipped with and the signals which are available.

Remember that with many external devices, the resolution of the video signal must be adjusted to the input sockets of the television (see the operating manual of the external device). You can find out which values you need to set by referring to the guidelines in the section about connection options.

Note:

Do not connect any other equipment while the device is switched on. Switch off the other devices as well before connecting them. Only plug the device into the mains socket after you have connected the external devices.

High definition – HD ready

Your television can playback high-definition television signals (HDTV).

You can connect the input sources (HDTV set-top box or High Definition DVD player) to the »HDMI« or »DVI-I« socket (digital HDTV signal).

This ensures that you can view digital HDTV programmes, even if they are copy-protected (HDCP High Bandwidth Digital Content Protection).

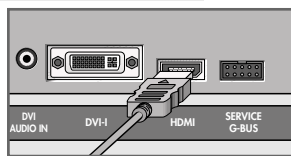

Connecting external devices

... With a digital audio/video signal

Video signal: digital video; resolution: standard 480p, 576p; HDTV 720p, 1080i, 1080p.

Audio signal: digital audio (stereo, multi-channel compression, uncompressed).

Preset »HDMI«.

- 1 Connect the »HDMI« socket on the television and the corresponding HDMI socket on the external device using a standard HDMI cable (digital video and audio signal).

USING EXTERNAL DEVICES

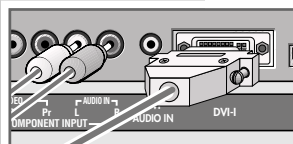
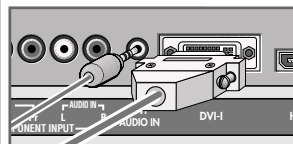
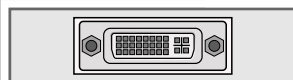

... With a digital audio/video signal

Video signal: digital video; resolution: standard 480p, 576p; HDTV 720p, 1080i, 1080p.

Audio signal: stereo, analogue.

Preset »DVI Digital«.

- 1 Connect the »**DVI-I**« socket on the television and the corresponding DVI socket on the external device using a standard DVI cable (digital video and audio signal).
- 2 Connect the »**DVI AUDIO IN**« (3.5 mm jack) or »**AUDIO IN L R**« socket on the television and the corresponding sockets on the external device using an RCA cable (audio signal).

Note:

In the »Devices« menu you may have to select the DVI audio signal (see "Changing the AV settings" on page 22).

You can also connect a device with an HDMI socket to the DVI socket. An adapter cable is supplied with the device.

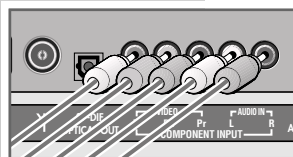

... With an analogue video signal (progressive)

Video signal: YUV; resolution: standard 480p, 576p; HDTV 720p, 1080i.

Audio signal: stereo, analogue.

Preset »YPbPr«.

- 1 Connect the »**COMPONENT INPUT VIDEO Y Pb Pr**« sockets on the television to the corresponding sockets of the external device with RCA cables (video signal).
- 2 Connect the »**COMPONENT INPUT AUDIO IN L R**« sockets on the television to the corresponding sockets of the external device with RCA cables (audio signal).

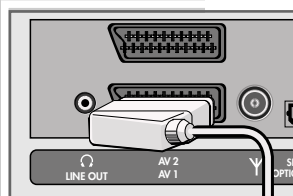
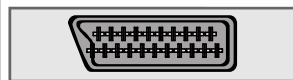

... Using the SCART socket

Video signal: FBAS, Y/C, RGB.

Audio signal: stereo, analogue.

Preset »AV1« or »AV2«.

- 1 Connect the »**AV 1**« or »**AV 2**« socket on the television and the corresponding socket on the external device using a SCART cable (video and audio signal).

USING EXTERNAL DEVICES

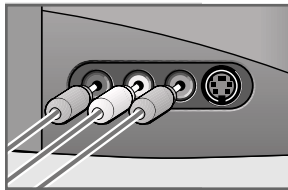
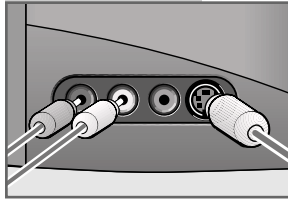

... With S-Video signal

Video signal: Y/C.

Audio signal: stereo, analogue.

Preset »C-AV«.

- 1 Connect the S-Video (S-VHS) socket on the television and the corresponding socket on the external device using an S-Video cable (video signal).
- 2 Connect the red and white (L AUDIO R) sockets on the television to the corresponding sockets of the external device with RCA cables (audio signal).

... With an analogue TV signal

Video signal: FBAS.

Audio signal: stereo, analogue.

Preset »C-AV«.

- 1 Connect the yellow (VIDEO) socket on the television to the corresponding socket of the external device with an RCA cable (video signal).
- 2 Connect the red and white (L AUDIO R) sockets on the television to the corresponding sockets of the external device with RCA cables (audio signal).

Changing the AV settings

In the »Device connections« menu you can adjust the AV sockets to the signals from the devices connected to them.

- 1 Open the »EASY DIALOG« menu by pressing »i«.
 - The »EASY DIALOG« menu appears.
- 2 Select »Installation« with »P+« or »P-« and press »OK« to confirm.
 - The »Installation« menu appears.
- 3 Select »Devices« with »P+« or »P-« and press »OK« to confirm.
 - The »Devices« menu appears.
- 4 Select the AV socket with »P+« or »P-« and press »OK« to confirm.
 - The menu for the selected AV socket appears.
- 5 Select the line using »P+« or »P-« and press »OK« to confirm.
- 6 Make the setting with »P+« or »P-« and press »OK« to confirm.

Note:

If you want an explanation of the setting, just press »?«.

- 7 Press »i« to conclude the setting.

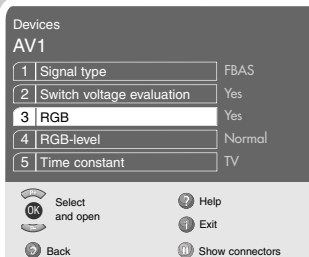
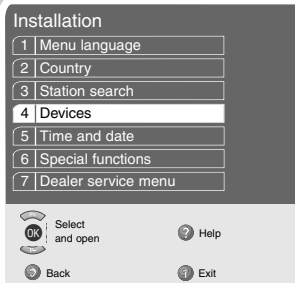

USING EXTERNAL DEVICES

Video recorder, DVD player or set-top box

Connecting a video recorder, DVD player or set-top box

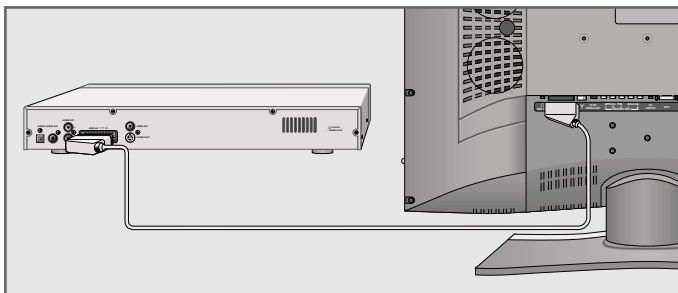

- 1 Connect the socket of the television and the corresponding socket of the video recorder, DVD player or set-top box with a SCART cable.

Using a DVD player, DVD recorder, video recorder or set-top box

- 1 Switch on the external device and select the function you want to use.
- 2 Press **»AV«**, then use **»P+«** or **»P-«** to select the preset for the input signal (**»AV1«**, **»AV2«**, **»YPbPr«**, **»DVI Digital«** or **»HDMI«**) and press **»OK«** to confirm.

Headphones

Connecting the headphones

- 1 Plug the headphones (3.5 mm jack plug) into the headphone socket on the back of the device.

Selecting audio settings for the headphones

- 1 Open the **»Sound«** menu by pressing **»?«**.
- 2 Select **»Headphone sound settings«** or **»Headphone volumes«** with **»P+«** or **»P-«** and press **»◀«** or **»▶«** to make the setting.
- 3 Press **»i«** to conclude the setting.

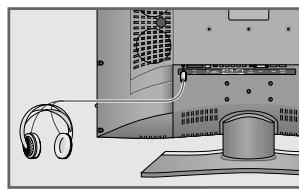

USING EXTERNAL DEVICES

Decoder or satellite receiver

A decoder is needed if the television receives encoded programmes from a privately operated station.

Connecting a decoder or satellite receiver

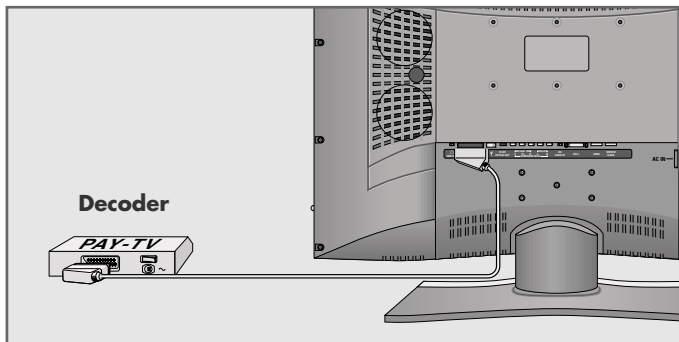

- 1 Connect the »AV 1« socket on the television and the corresponding socket on the decoder using a SCART cable.

Using a decoder or satellite receiver

- 1 Switch on the television and the decoder or satellite receiver.
- 2 Press »AV«, press »P+« or »P-« to select the »AV1« preset and press »OK« to confirm.

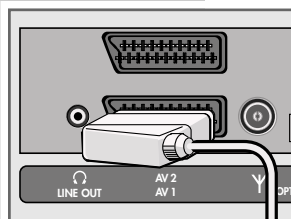

Digital multi-channel amplifier/AV receiver

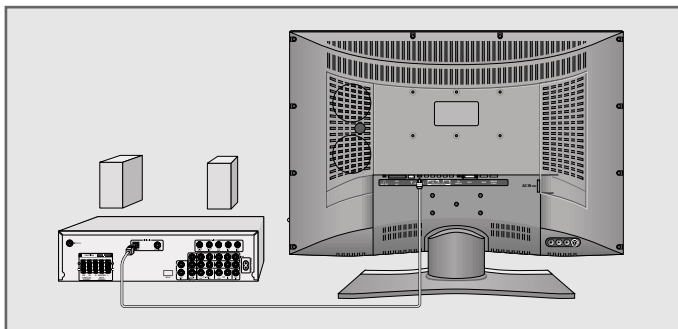

- 1 Plug a standard optical digital cable into the »SP-DIF OPTICAL OUT« socket on the digital receiver and the corresponding input socket on the digital multi-channel amplifier/AV receiver.

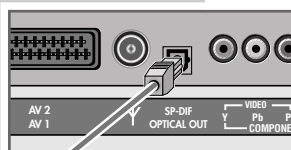

USING EXTERNAL DEVICES

Camcorders

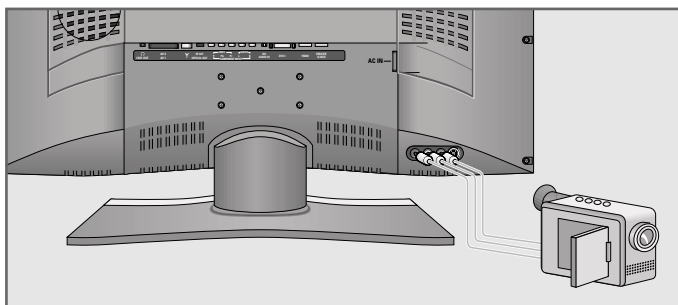

Connecting a camcorder

- 1 Connect the yellow »**VIDEO**« socket of the television and the video output socket of the camcorder (VHS, Video 8) using an RCA cable (video signal),

or

connect the »**S-VHS**« socket (video signal) of the television and the S-Video output socket of the camcorder (VHS, Hi 8) using an S-Video cable.

- 2 Connect the red and white »**L AUDIO R**« sockets on the television to the audio output sockets of the camcorder using RCA cables (audio signal).

Note:

In the »Devices« menu you may have to select the video signal (see "Changing the AV settings" on page 22).

There must not be video signals at »**VIDEO**« and »**S-VHS**« sockets at the same time. This could lead to picture disturbances.

Operation with a camera recorder

- 1 Press »**AV**«, press »**P+**« or »**P-**« to select the »**C-AV**« preset and press »**OK**« to confirm.
- 2 Switch on the camcorder, put in a cassette and start playback.

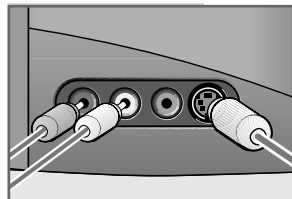
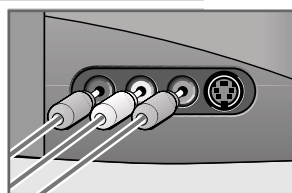

OPERATION AS A PC MONITOR

Connecting a PC

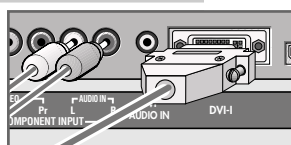
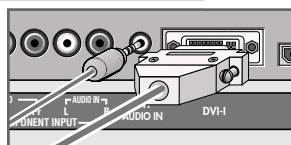
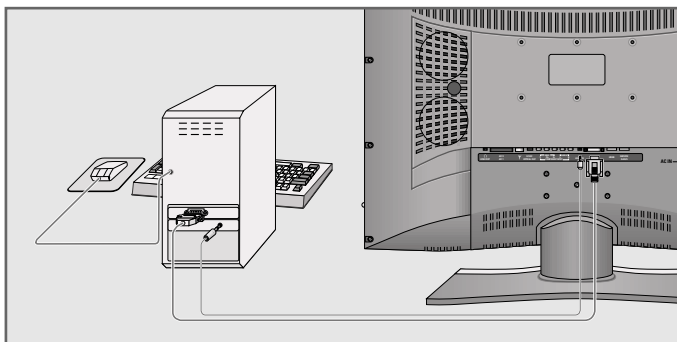

- 1 Connect the »DVI-I« socket on the television to the corresponding socket on the PC using a DVI cable (digital video signal) or a DVI – VGA cable (analogue video signal).
- 2 Connect the »DVI AUDIO IN« or »AUDIO IN L R« socket on the television to the corresponding socket on the PC using a suitable cable (audio signal).

Note:

Adjust your PC to the monitor (for example, picture resolution 1024 x 768, picture frequency 60 Hz).

In the »Devices« menu you may have to select the DVI audio signal (see "Changing the AV settings" on page 22).

Selecting the preset for the PC

- 1 Press »AV«, then use »P+« or »P-« to select the »DVI Analog« preset (analogue video signal) or »DVI Digital« (digital video signal) and press »OK« to confirm.

RETROFITTING A DIGITAL RECEIVER

Connecting a micro digital receiver to a television set

You can retrofit your television with a micro digital receiver. Your dealer can recommend an appropriate receiver for you.

The user guide for the receiver can be integrated into the television user guide by following a brief installation procedure. After installing, the receiver can be controlled with the television remote control. The remote control, the infra-red mouse and the power supply for the receiver will then no longer be needed.

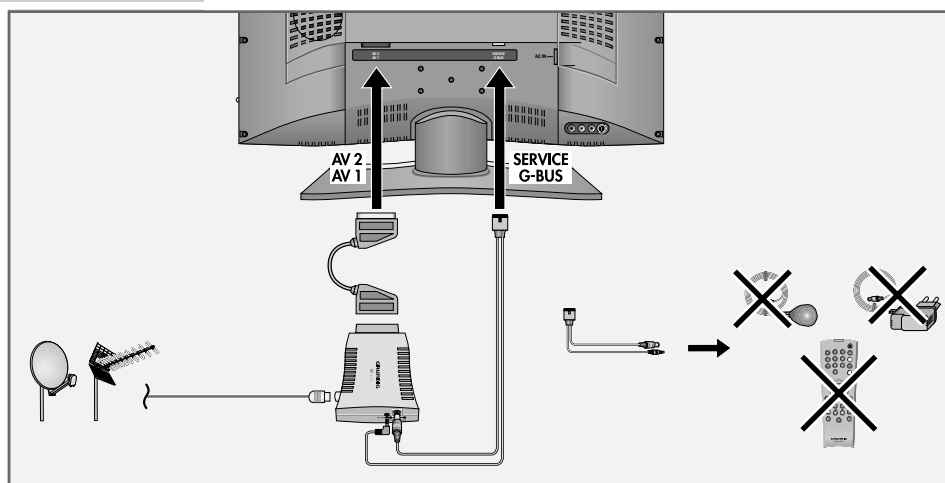

Connecting the communication line to the receiver

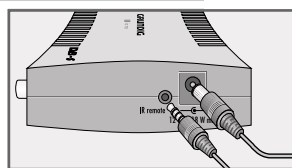

- 1 Plug the communication line into the »IR remote« and »12 VDC« sockets.

Note:

The communication line is supplied with the television.

Connecting the communication line to the television set

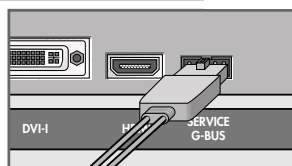

- 1 Plug the communication line into the »SERVICE G-BUS« socket on the television.

Note:

The remote control, the infra-red mouse and the power supply for the receiver will then no longer be needed.

RETROFITTING A DIGITAL RECEIVER

Installing on the television set

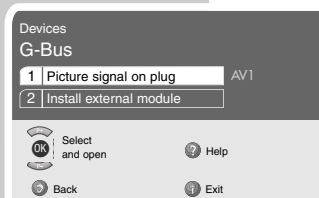

- 1 Switch on the television.
- 2 Open the »EASY DIALOG« menu by pressing »i«.
- 3 Select »Installation« with »P+« or »P-« and press »OK« to confirm.
- 4 Select »Devices« with »P+« or »P-« and press »OK« to confirm.
- 5 Select »G-Bus« with »P+« or »P-« and press »OK« to confirm.
- 6 Select »Picture signal on plug« with »P+« or »P-« and press »OK« to confirm.
- 7 Select the Euro AV socket with »P+« or »P-« and press »OK« to confirm.
- 8 Select »Install external module« with »P+« or »P-« and start the installation with »OK«.

Note:

When the installation has been successfully completed, the »First Time Installation« page appears.

You can find further settings in the digital receiver user guide.





RETROFITTING A DIGITAL RECEIVER

Operating the receiver with the television remote control







Note:

The receiver must be connected and installed to the G bus on the television set via the communication line.

-  Switches the television off (standby).
- 1...0** Switches the television on from standby mode.
Selects channels directly.
- ?** Displays information on the selected function.
You receive the station information of the digital receiver after changing station or by looking in the electronic TV guide.
-  Opens the »Format« menu.
Then use **P+** or **P-** to make the selection.
- PIP** Displays an inset picture.
Returns to normal picture.
- AV** Opens the pre-selection for AV channels.
Then select with **P+** or **P-**.
-  Sound on/off (mute).
- i** Opens the television »EASY DIALOG« menu (main menu).
You can find the main menu of the digital receiver in the »EASY DIALOG« menu.
- Z** Switches back one menu level in the receiver.
- P+, P-** Switch the television on from standby;
Select stations step by step;
Move the cursor in the menus up and down.
-  Adjust the volume;
Move the cursor left/right.
- OK** Opens the station or favourites list on the receiver;
activates various functions.
- TXT** Switches between teletext mode and TV mode on the television (only the television teletext can be used).
- TV-G** Opens and closes the electronic TV guide on the receiver.

RETROFITTING A DIGITAL RECEIVER



-  Opens the »Picture« menu of the television.
-  Shows/hides the time and station information.
-  Freeze-frame.
-  Opens the »Sound« menu of the television.

SCAN Switches to TV mode.

PAT Selects the split screen function.

S Switches to radio mode.

P Switches between the last two selected stations;
Switches from the station list to the favourites.

DR, DVD Switches to operation of a GRUNDIG digital receiver, GRUNDIG digital receiver with hard disc (PDR), GRUNDIG DVD players or GRUNDIG DVD recorder.

Keep the appropriate button (»DR«, »DVD«) pressed down. Then press the appropriate button.

Note:

The »DR« button has been programmed for operating a GRUNDIG digital receiver (remote control level 1).

The »DVD« button has been programmed for operating a GRUNDIG DVD player.

You can change this programming, see the »AUX« button.

The functions available depend on the model of the device you are using.

Just try it out.

AUX Programmes the remote control for the operation of external devices.

Press »AUX« and hold it down and then simultaneously press three number buttons to enter the code:

»1«, »2«, »3« for a GRUNDIG DVD player.

»4«, »5«, »6« for a GRUNDIG DVD recorder.

»1«, »4«, »7« for a GRUNDIG digital receiver (remote control level 1).

»2«, »5«, »8« for a GRUNDIG digital receiver (remote control level 2).

»3«, »6«, »9« for a GRUNDIG digital receiver with a hard disc (PDR).

INFORMATION

Technical data

Mains voltage:	230 V, 50/60 Hz, (power supply control range 190 to 264 V)
Power consumption:	107 W during operation (Vision+ 26) 145 W during operation (Vision+ 32) approx. 2 W in standby mode
Audio output stage:	Front 2 x 10 W music power (2 x 6 W sine wave) Subwoofer 18 W music power (10 W sine wave)
Reception ranges:	C01 ... C99, special channels S01 ... S41
Preset channels:	99 and 7 AV
Screen size:	66 cm / 26" (Vision+ 26) 81 cm / 32" (Vision+ 32)
Max. resolution:	WXGA 1366 x 768
Weight (WEEE):	18.81 kg (Vision+ 26) 25.31 kg (Vision+ 32)

Service information for dealers

The product complies with the following EU directives:
73/23/EEC directive on electrical equipment for use within certain voltage limits. 89/336/EEC, 2006/95/EG directive on electromagnetic compatibility.

The device complies with the following standards: EN 60065, EN 55013, EN 55020.

Environmental note

This product has been made from high-quality parts and materials which can be re-used and recycled.

Therefore, do not throw the product away with normal household waste at the end of its life. Take it to a collection point for recycling electrical and electronic devices. This is indicated by this symbol on the product, in the operating manual and on the packaging.

Please find out about collection points operated by your local authority.

Help protect the environment by recycling used products.



INFORMATION

Troubleshooting

If the remedies given below do not work, please consult an authorised GRUNDIG dealer. Please bear in mind that malfunctions can also be caused by external devices such as video recorders or satellite receivers.

Problem	Possible cause	Remedy
Screen lit (snow or blue), but no picture	Antenna cable	Antenna cable connected? Check antenna?
Poor contrast	Picture settings shifted	Adjust the brightness, contrast or colour setting
No colour	Problem at station	Test with a different channel
	Colour intensity too low	Turn up the colour
	TV standard setting (if setting option is available)	Select the correct colour standard
Sound unclear	Problem at station	Test with a different channel
	Sound setting	Correct the sound setting
Ghosting, reflection	Channel setting	Automatic or manual tuning/fine tuning
	Antenna	Have antenna cable or system checked
Picture but no sound	Volume turned down or speaker switched off	Turn up or switch on the volume
	Audio control via RCA audio sockets activated (if this option is available)	Select sound output via loudspeaker
	Problem at station	Test with a different channel
Teletext impaired or absent	Television station has no teletext or antenna system	Test with a different channel, fine tuning may eliminate ghosting or reflections
	Station signal too weak (picture interference)	Check antenna
Remote control does not work	No optical connection	Point remote control at television
	Remote control batteries	Check the batteries, change if necessary. Ensure correct polarity
	Operating mode undefined	Switch off the television with the power button for 2 minutes
Parental control warning appears when switched on	Parental control has been activated	Enter secret number or number combination 7038580.
You cannot understand the menu language	Wrong menu language set	Select the »Language« menu with »i«, »3«, »OK« and set the correct language
No picture/sound on AV preset (SCART socket)	The SCART cable is not connected correctly	Plug in the cable properly

NOTE:

This is a Class A product. During operation the device can cause radio interference. In this case the user may have to remedy this. Please contact your specialist dealer.

INFORMATION

Additional Information for units sold in the UK.

Units sold in the UK are suitable for operation from a 240V ac, 50Hz mains supply.

The range of multi-system receivers is built to work in most European countries. However, the mains plug and socket system for the UK differs from many European countries.

This appliance has been supplied with a fitted, non-removable, approved converter plug for use in the UK. This converter plug is fitted with a 5A rated fuse.

In case this appliance is supplied with a moulded 2-pin Euro plug only, which is unsuitable for UK operation, this must be cut off and immediately disposed of. An approved 13A, 3-pin UK plug should then be fitted by a qualified electrician.

Note:

The severed Euro plug must be destroyed to avoid a possible shock hazard should it be inserted into a socket elsewhere.

If a non-rewireable 3-pin plug or a rewireable 13A (BS1363) 3-pin plug is used, it must be fitted with a 5A ASTA or BSI approved BS1362 fuse. If any other type of plug is used it must be protected by a 5A fuse either in the plug, or at the distribution board. If this type of plug becomes defective, ensure that the fuse is removed before disposal, to eliminate potential shock hazard.

If it is necessary to change the fuse in the non-rewireable plug, the correct type and rating (5A ASTA or BSI approved BS1362) must be used and the fuse cover must be refitted. If the fuse cover is lost or damaged, the lead and plug must not be used until a replacement is obtained. Replacement fuse covers should be obtained from your dealer.

Important:

The wires in the mains lead are colour coded in accordance with the following code:

BLUE – NEUTRAL

BROWN – LIVE

As the colours of the wires in the mains lead of your appliance may not correspond with the coloured marking identifying terminals in your plug, proceed as follows:

Connect the BLUE coloured wire to plug terminal marked with the letter "N" or coloured black.

Connect the BROWN coloured wire to the plug terminal marked with the letter "L" or coloured red.

In no circumstance must any of the wires be connected to the terminal marked with the letter "E", earth symbol "⏏", coloured green, or green & yellow.

Grundig Multimedia B.V.

Atrium, Strawinskylaan 3105 • NL-1077 ZX Amsterdam • <http://www.grundig.com>

07/24